





.....

.....

.....

.....

.....

.....

.....

.....

.....

.....

.....

.....

.....

.....

.....

.....

.....

.....

.....

.....

.....





✘







•

•

•

•

•

•

-
- -
 -
 -



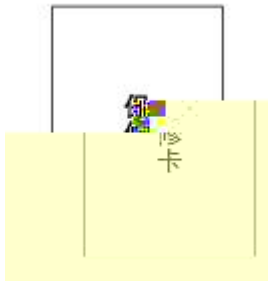
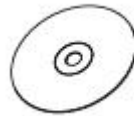

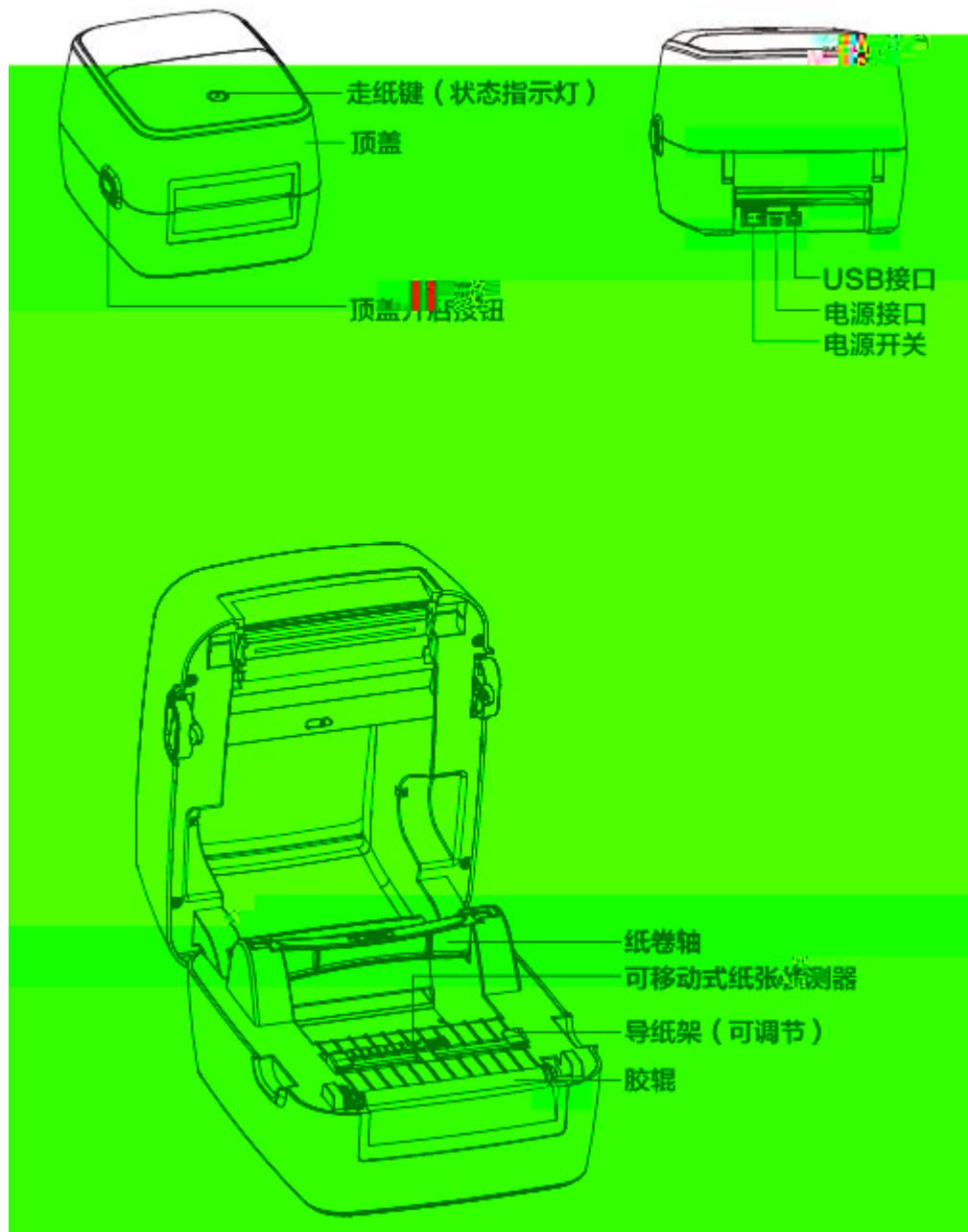

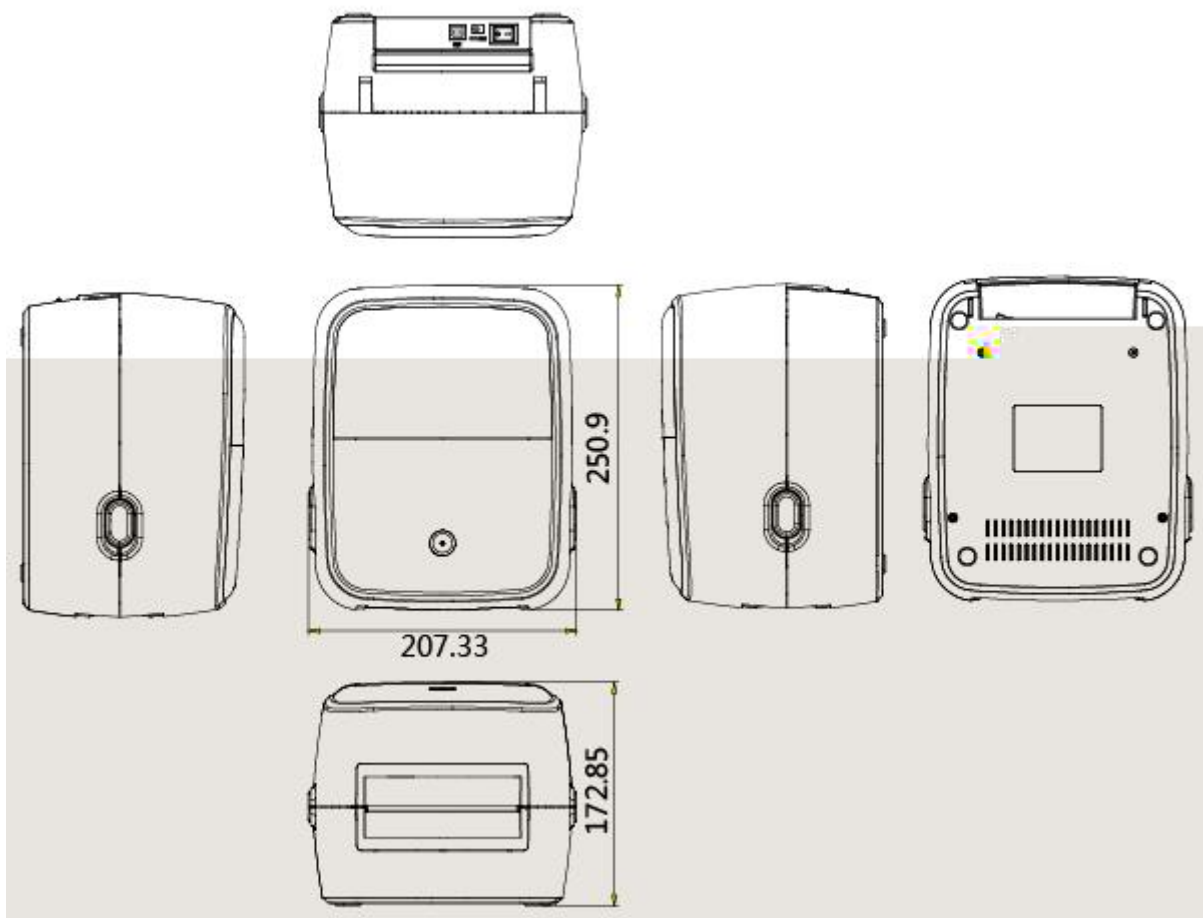







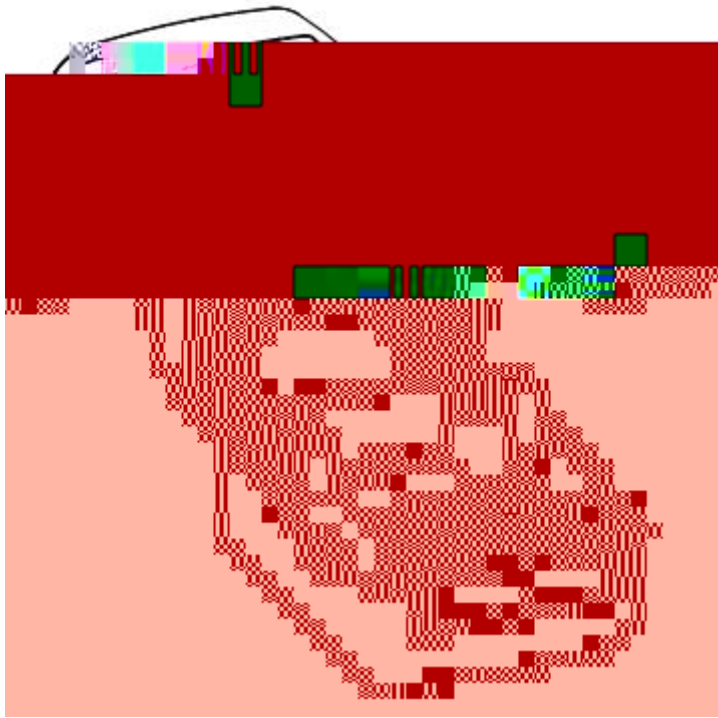
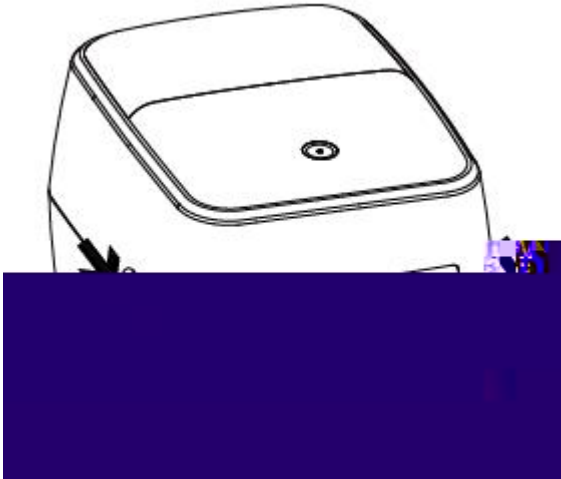

① 使用1吋纸卷时, 请将纸卷轴标有“1' CORE”

面向上、装入纸卷

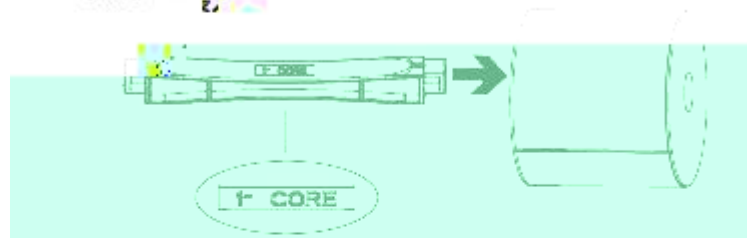

② 使用1.5吋纸卷时, 请将纸卷轴标有“1.5' CORE”

面向上、装入纸卷

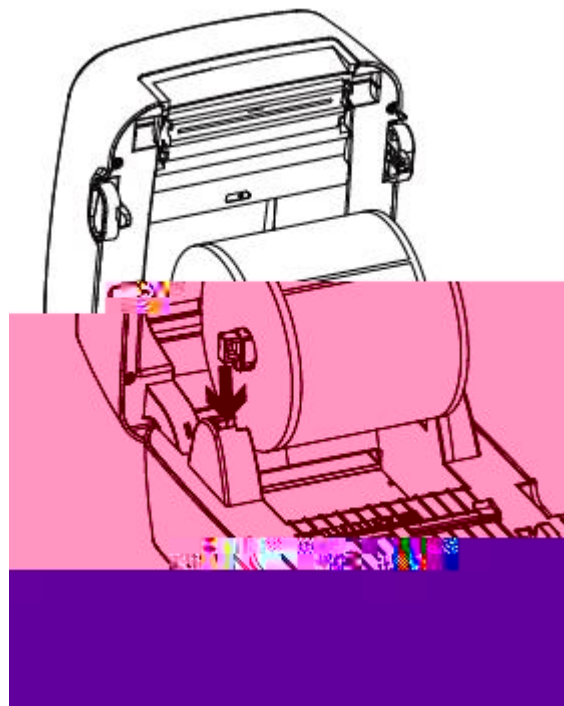
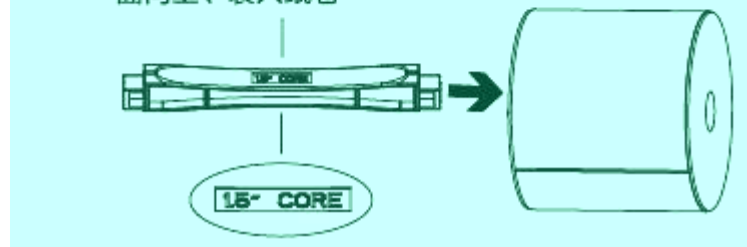

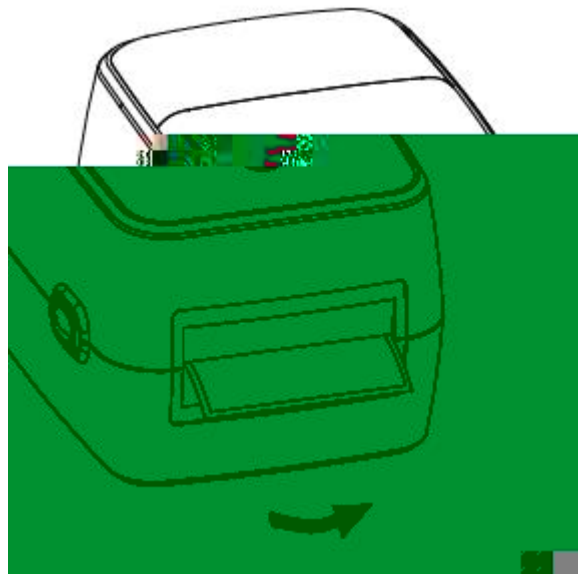
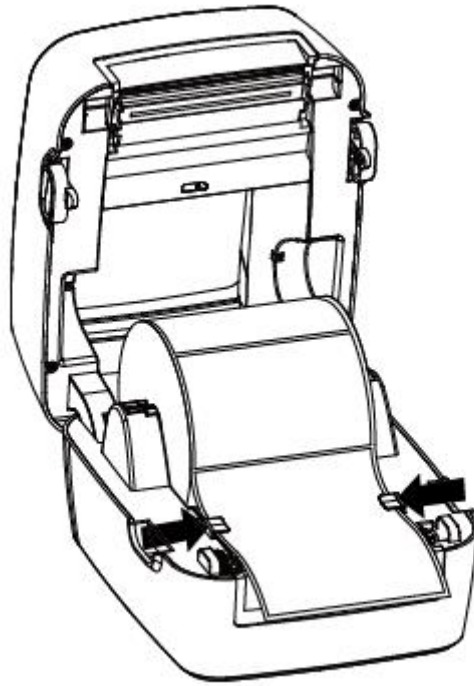

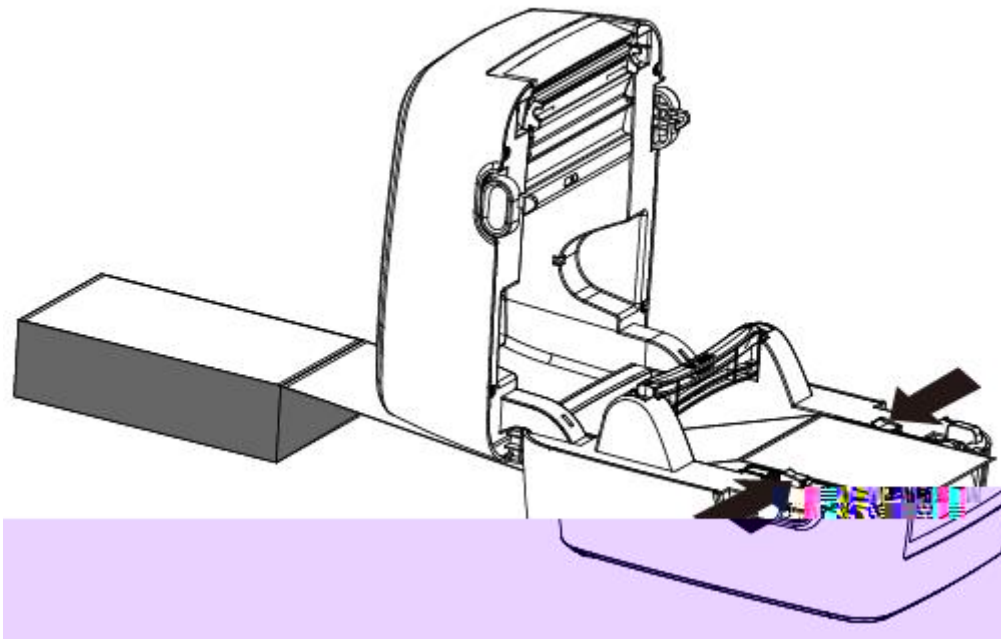
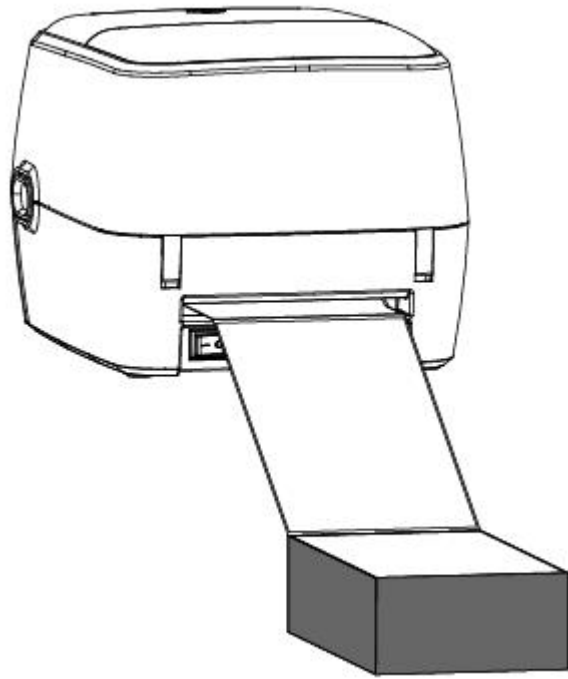



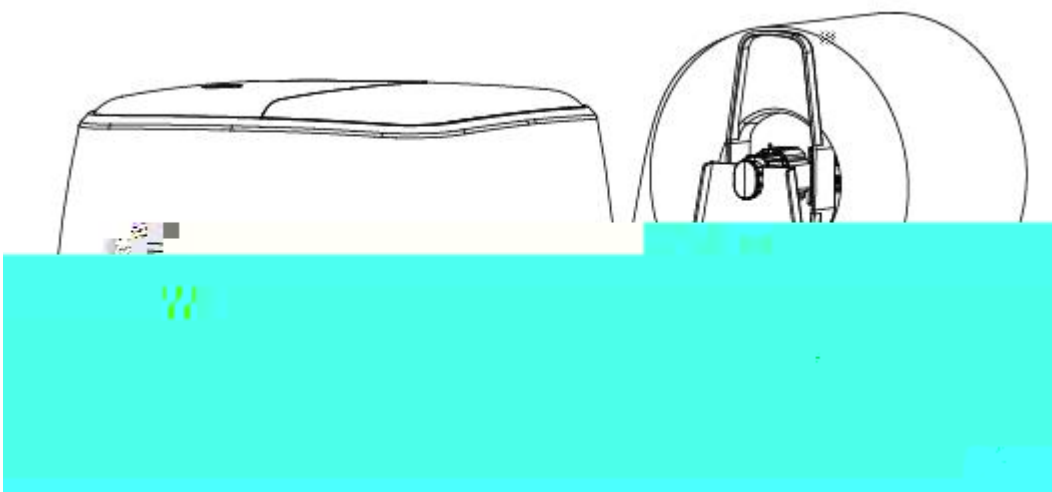
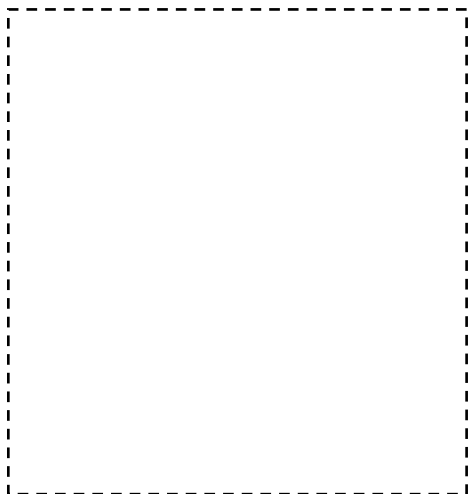

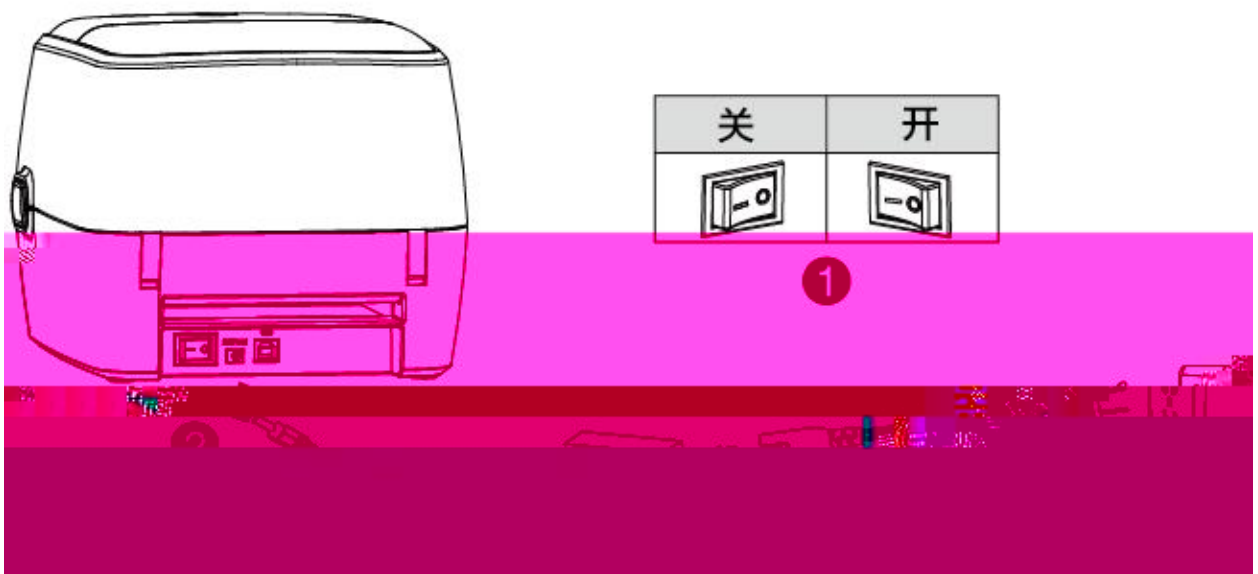

-
-
-

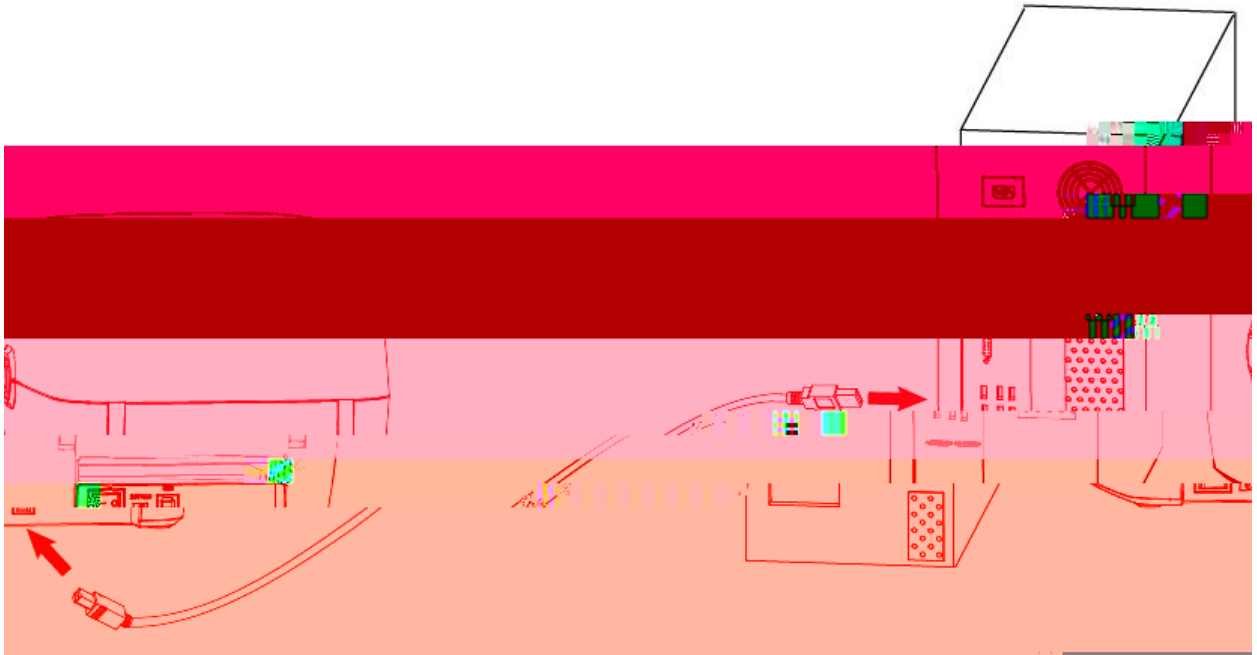

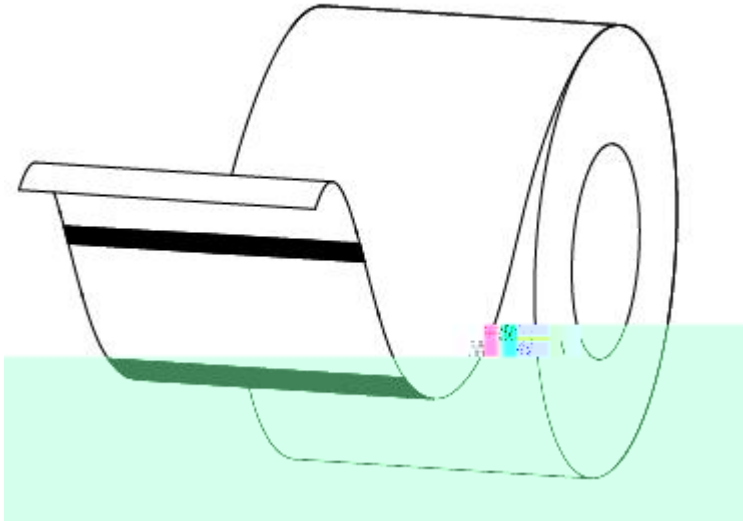
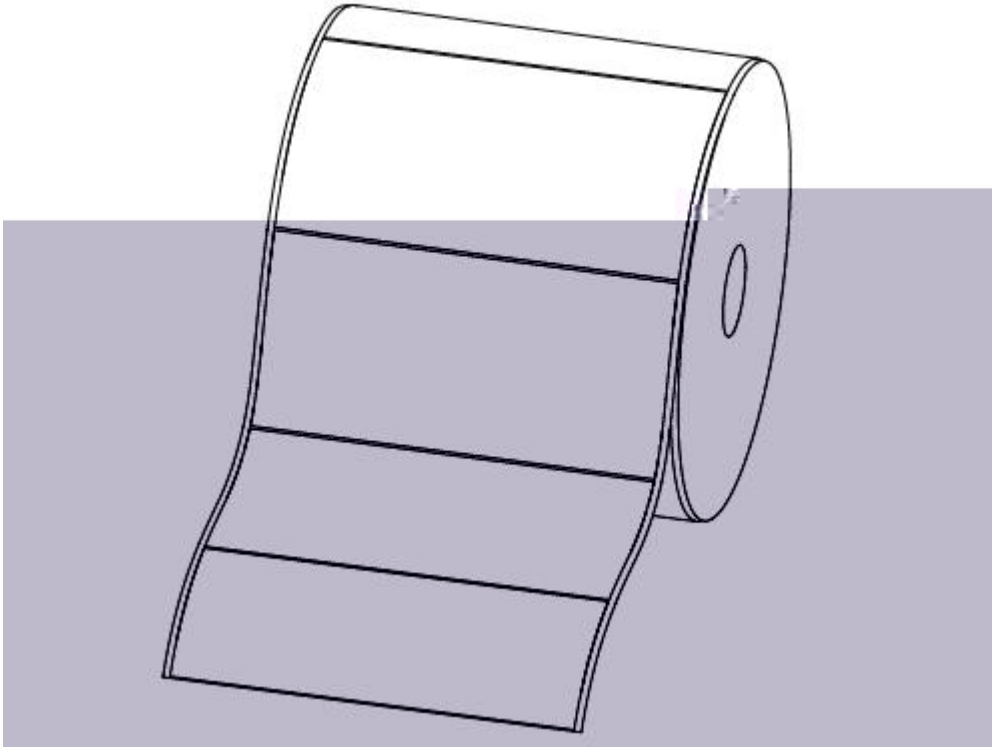

-

-

-

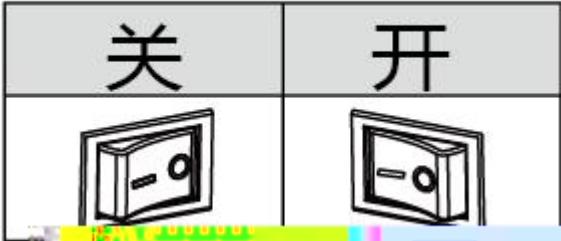



-
-
-
-
-
-





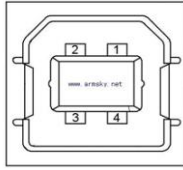

| 引脚号 | 信号名称 |
|-----|------|
| 1 | VBUS |
| 2 | D- |
| 3 | D+ |
| 4 | GND |



