



GB18030

4

16

1-1

1-2

1-3

1-4

2-1

2-1-1

2-1-2

2-1-3

2-2

2-3

2-3-1

2-3-2

2-4

2-5

3-1

3-1-1

3-1-2

3-2

3-2-1

3-2-2

3-3

4-1

4-2

5-1

5-2

1-1

1-2

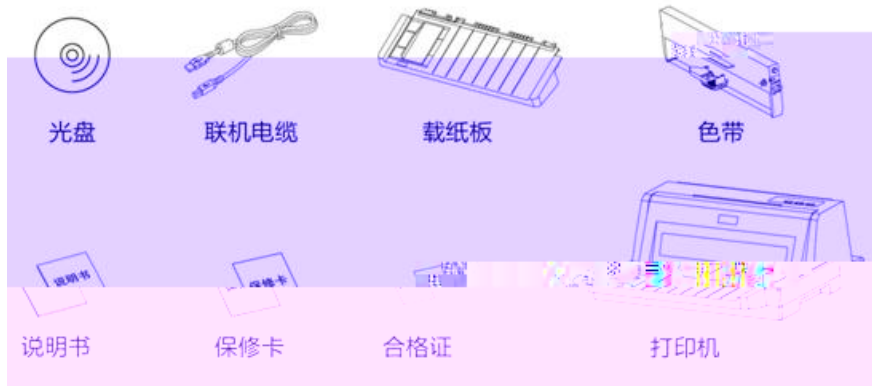

1-3

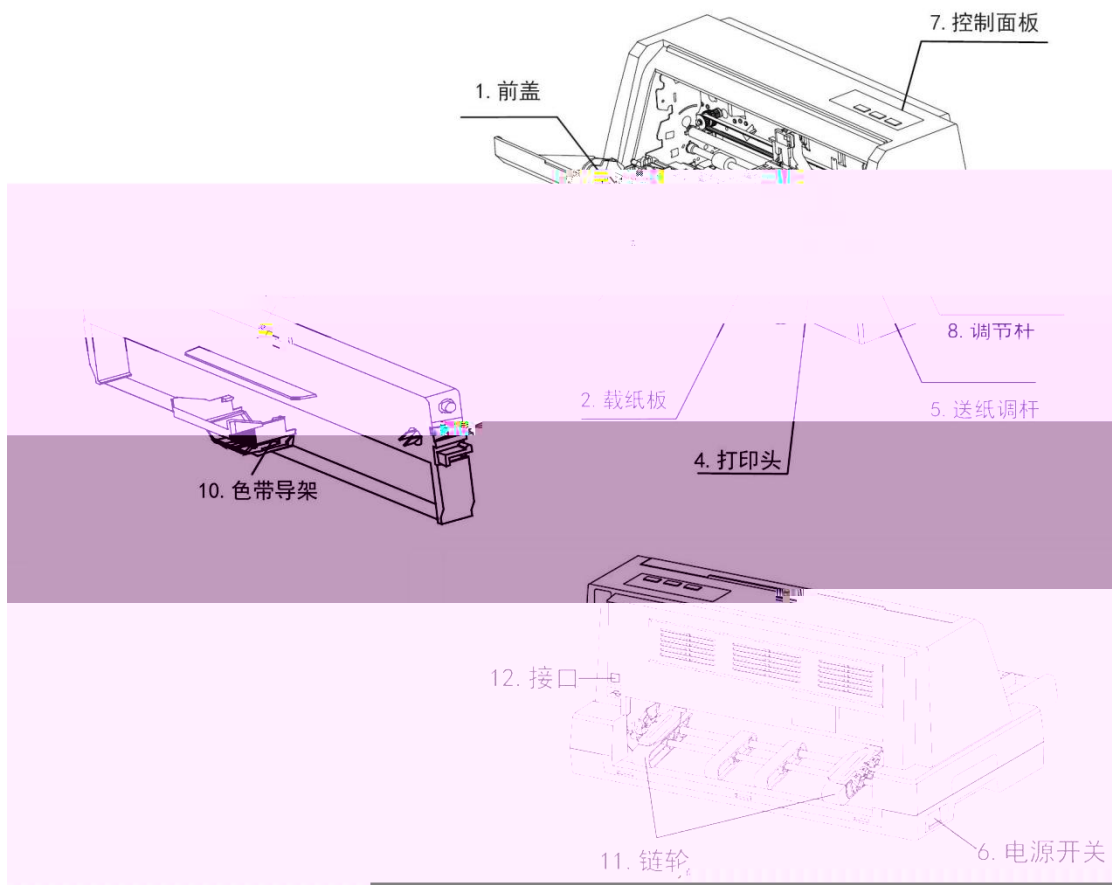



1-4



1

1

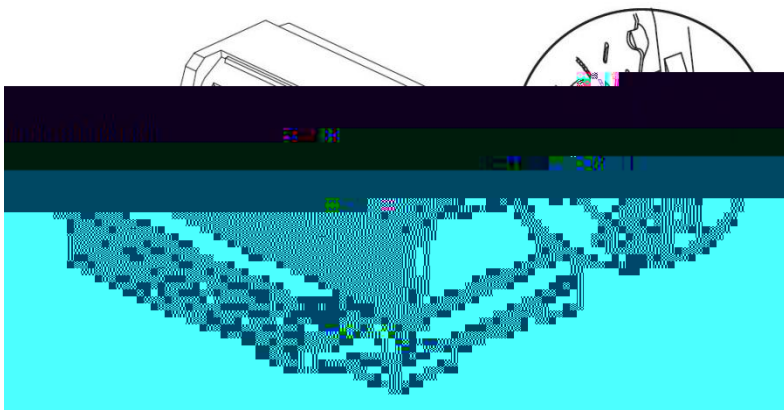

1

2

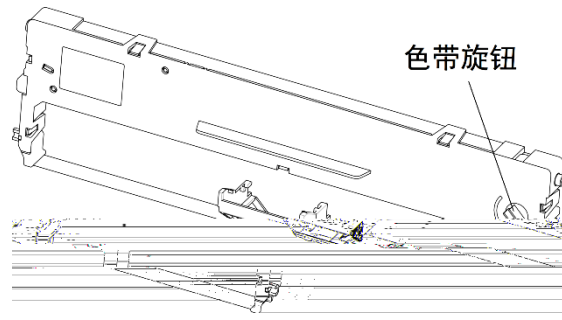

2

3

1 2 3

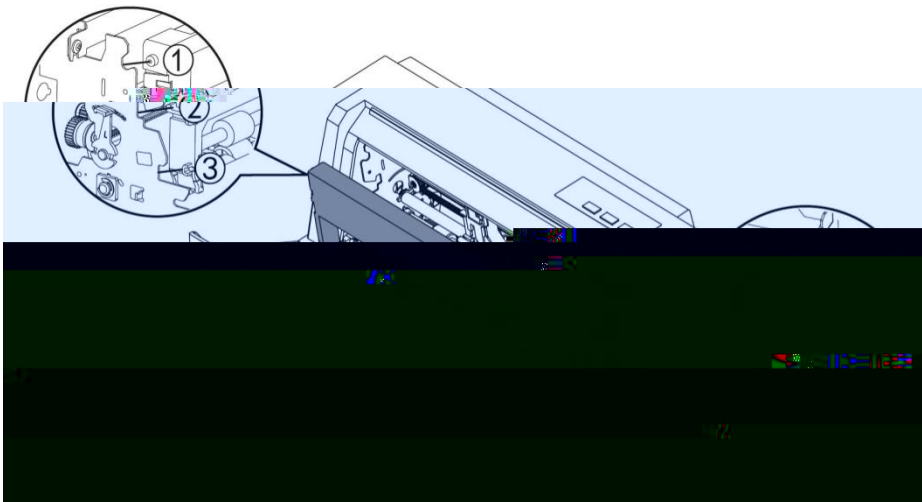

3

4

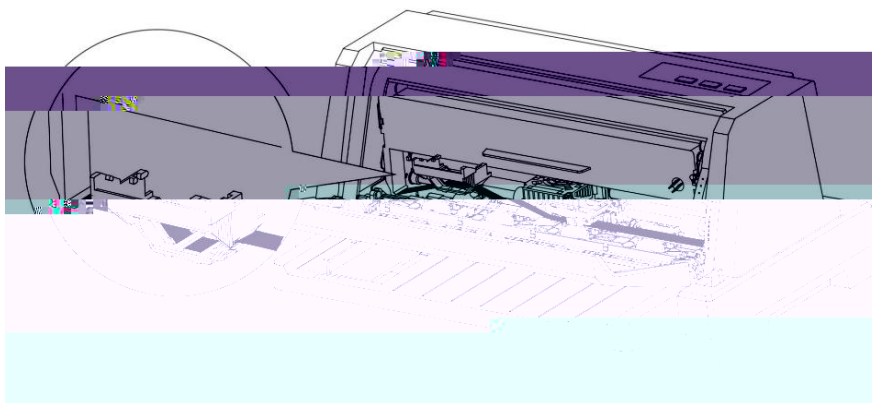

4

5

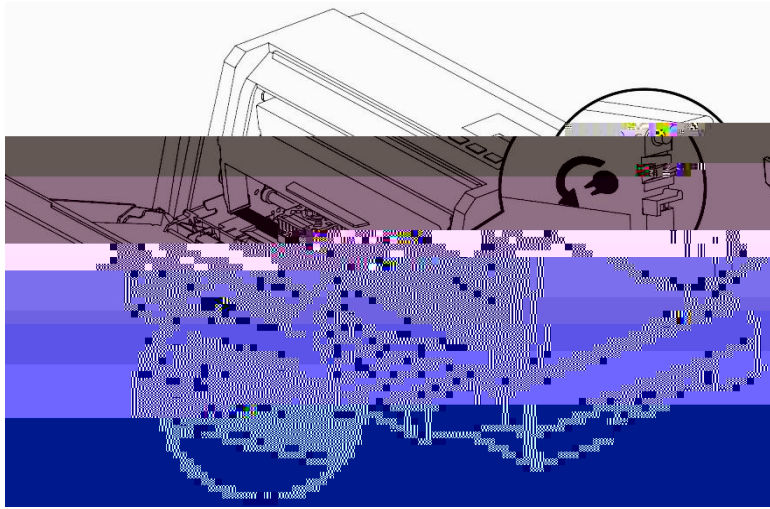

5

6



1)

2)

6

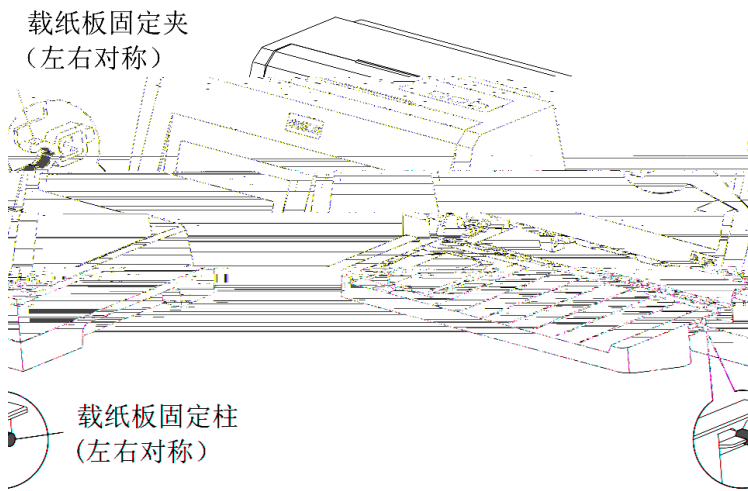

6



1

2

USB

7

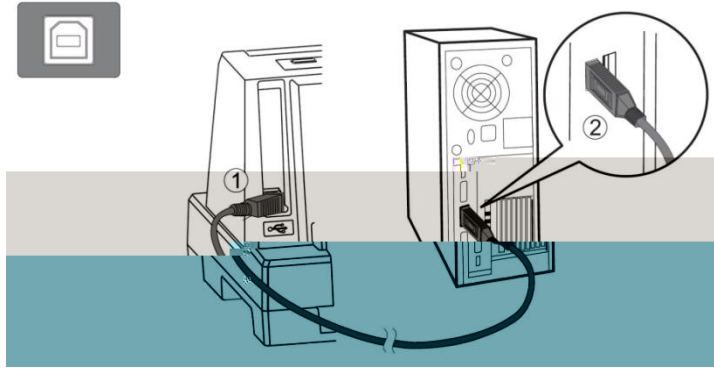

1) 8

2)



8

1.

5

2.

- 1
- 2
- 3
- 4

2-1

2-1-1

1

	2.5	-11.7	/64	-297
	2.5	-14.3	/64	-364
	A6	105	*148	
	B6 JIS	128	*182	
	A5	148	*210	
	B5	182	*257	
	A4	210	*297	
	B4 JIS	257	*364	
	Executive	7.25	*10.5	
	Letter	8.5	*11	
	LEGAL	8.5	*14	
		30-156	/	
		40-52	/	
		0.07-0.18		
		0.07-1.2		

2

	3 -10.5	
	5.5 / 139.7	
		52-82 /
		40-52 /
		0.07-0.11
		0.07-1.2

2-1-2

1

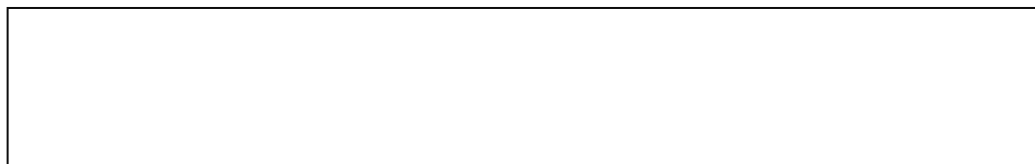
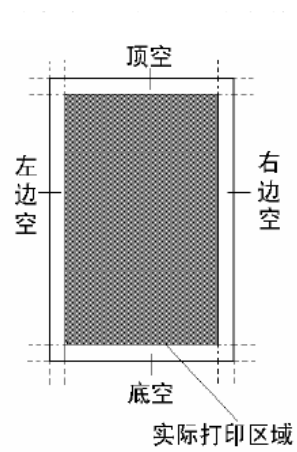

2

11.7

8.5

2-1-3

1)

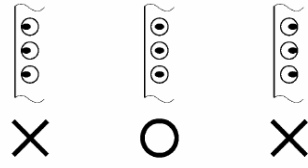

2)

2-2

1)

1

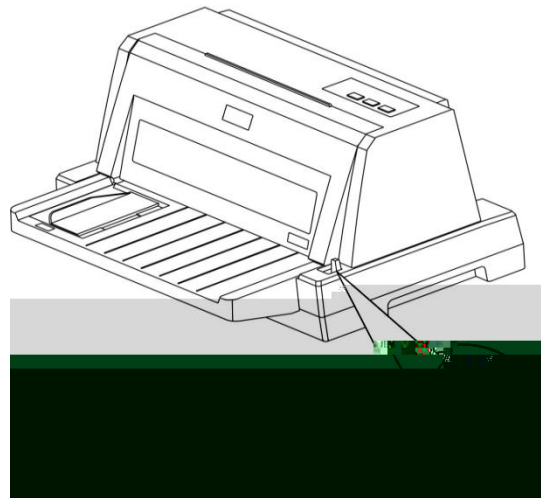

1

2)

2

2-4

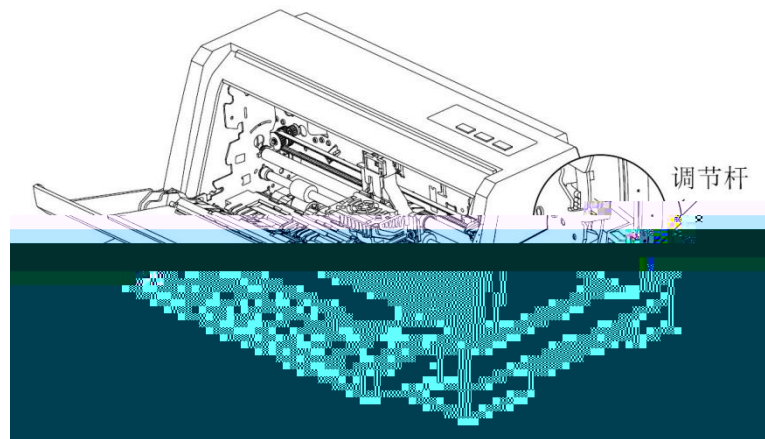

2

3) 3

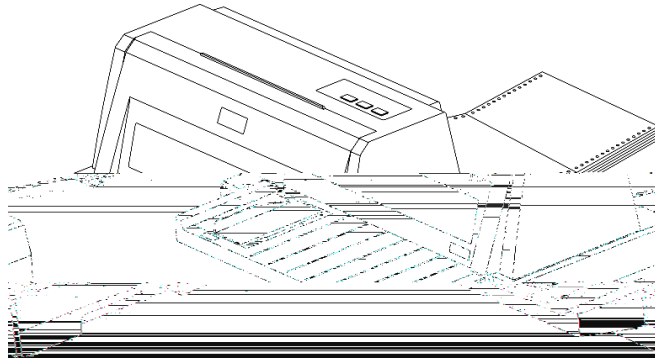

3

4)

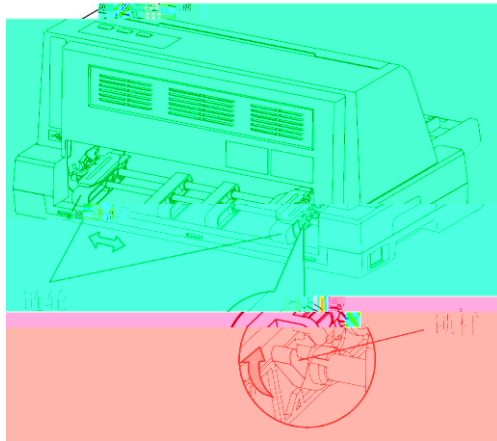

4

5)

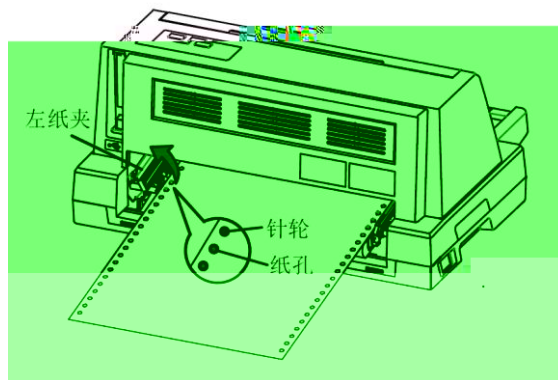

5

6)

7)

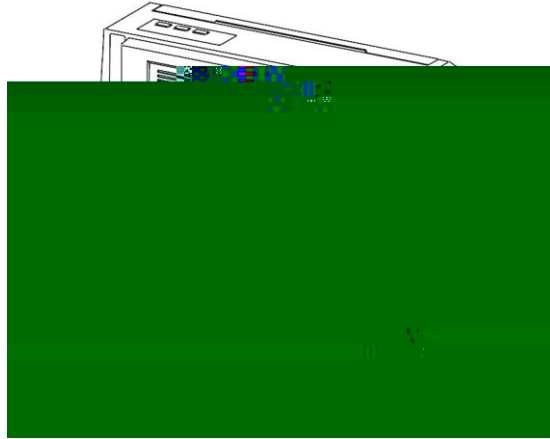

6

8)

9)

/

2-3

2-3-1

1

2

2-3-2

1)

1

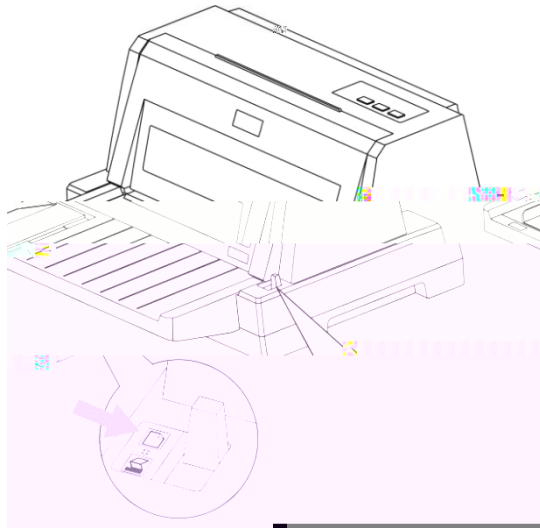

1

2)

2



2

3)

2-4

4)

5)

3

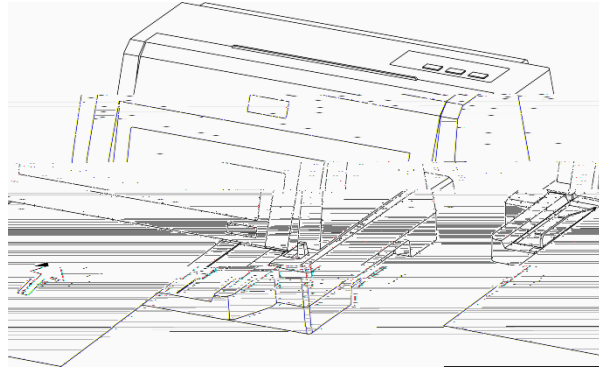

3

2-4

			1 2
			1 2
	2	+1	2
	3	+2	3
	4	+3	4
	5	+4	5
	6	+5	6
	7	+6	7
			5 6

2 2 ,

3 3 ,



a.

*





*

Windows

3-1

3-1-1

➤ / , / 2



/



/

2

/



2



,

3-3



/

ROM

EDS

➤

➤ EDS

/
EDS

➤

/

4-1



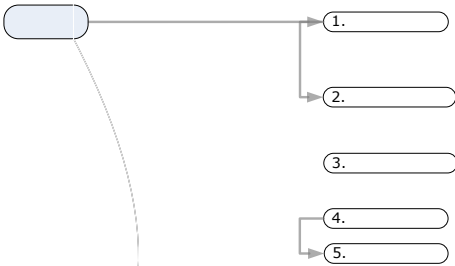

①

②



0

1-24

①

1 24

②

0



4-2-3

0

0

0

4-2-4

5-1



1)



2)



?	

?	

3

	
	1

	EDS

产品中有害物质的名称及含量

有害物质	
部件名称	
(PBB)	(PBDE)
外部组件	内部线路组件
马达组件	打印头组件
线路板组件	
电机线束组件	
零件	
文成电化	